

LED Linear High-Bay Installation Instructions

Cautions:

1. Cannot use the electric generator to test the LED light.
2. Please abide by related country, regional and local laws and regulations when installing this fixture.
3. Turn off the power before installation or maintenance.
4. Proper earth grounding is required to ensure safety.

Notes:

1. To avoid the possibility of electric shock or fire, the installation personnel must have professional electrical knowledge.
2. Please wear gloves to avoid injury before installation.
3. If any smoke or spark of the wire occurs, turn off the power immediately and notify the relevant personnel.
4. Please use listed strain relief bushing when connecting the supply cord to the outlet box.

Attention:

1. Check if there was any damage during shipping. If so, please contact the manufacturer timely.
2. Please read the installation instructions carefully to check whether all the accessories are complete. After confirmation, install the fixture according to the installation steps.

Wiring Diagram & Instructions:

3 dimming functions are available in this high-bay light:

1. Constant current can be achieved by 1-10VDC dimming
2. PWM signal dimming
3. Variation of resistance unit dimming

Wiring Instructions

L: Black

N: White

⊕: Green/Yellow

DIM +

DIM -

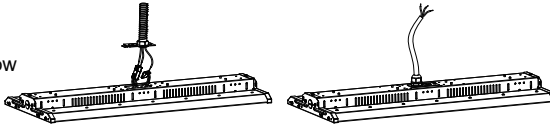

(For the wire color of DIM+ and DIM-, please check the light label.)

Description:

This product is 0-10 V dimming. The below dimmers are recommended:

Brand	Model
LUTON	NTSTV-DV
LEVITON	DS 710-10 Z / IP71 0
LEGRAND	RH4 FBL 3PW

Backup Driver Wiring

Step 1: Open junction box with a screwdriver

Step 2: Connect the input wires on each backup driver and fixture driver via suitable knockout, then complete the junction box.

Wiring Instructions

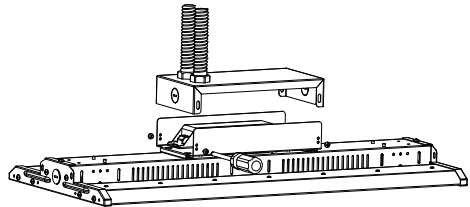
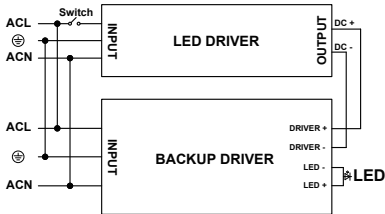

Please choose the appropriate dimming method according to your needs. You can also choose not to use this function.

*The product cannot be connected to a dimming device when it's equipped with a motion sensor.

Three installations: Chain/cable installation, 3/4"NPT installation, surface mounting

/ pendent mounting. (Please choose the most suitable installation method for the purchased product as per your needs.)

A. Hanging Installation: (chain/cable)

Step 1: Hook up the chain (figure 1)

Step 2: Connect the chain with fixture (figure 1)

Step 3: Fix the chain on the rail, adjust the chain length as per your needs; (figure 1)

Step 4: After the fixing, choose the suitable wiring knockout and carry out the wiring according to local standards and codes

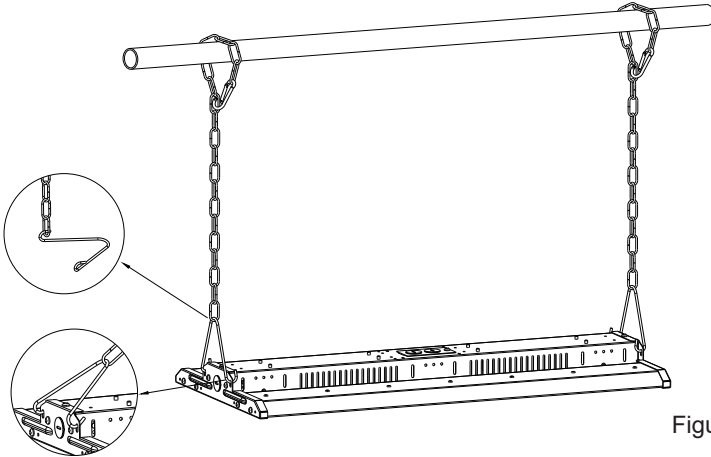

Figure1

B. 3/4" NPT Installation (if this bracket is used for the fixture, backup driver solution cannot be chosen)

Step 1: Mount the bracket on 3/4" NPT (figure 2)

Step 2: Lock fixture on the bracket (figure 3)

Step 3: Do wiring according to local standards and codes

Step 4: Lock side brackets with screwdriver (figure 4)

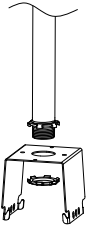

Figure2

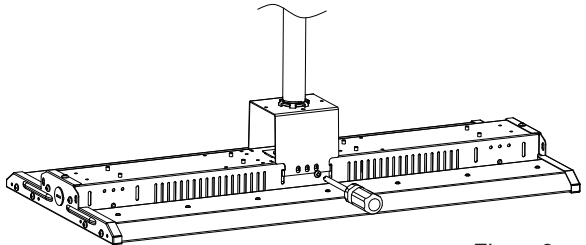

Figure3

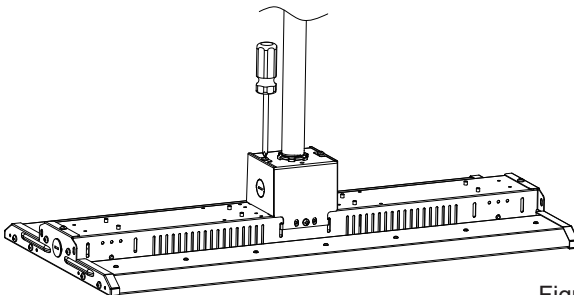

Figure4

C.Surface Mounting / Pendant Mounting:

Step 1: Mount the bracket on the rail or ceiling (figure 5)

Step 2: Mount bolt on the rail or ceiling, mount the fixture bracket onto the bolt (figure 6) and then install the fixture (figure 7)

Step 3: After mounting, choose suitable wiring knockout and carry out the wiring according to local standards and codes

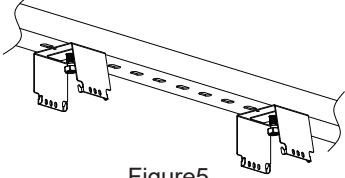

Figure5

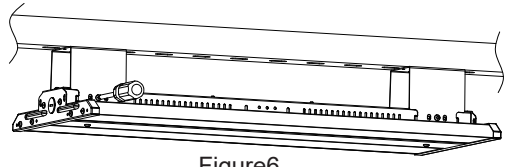

Figure6

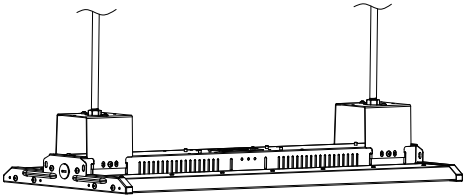

Figure7

Extra Accessory Option Installation: Wire guard, motion sensor / PIR Sensor, backup driver

1.Wire guard: (purchase the correct size wire guard from manufacturer)

Step 1: Mount the wire guard on the fixture with screws (figure 8)

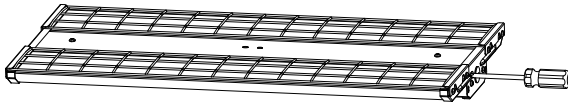

Figure8

2.Motion sensor / PIR Sensor: (both sensors require the same installation)

Step 1: Open the face cover with a screwdriver (figure 9)

Step 2: Knock out the side cover, mount the sensor on the side and carry out the wiring according to instructions on the sensor (figure 10)

Step 3: Put face cover back with screwdriver (figure 11)

Wiring Instruction

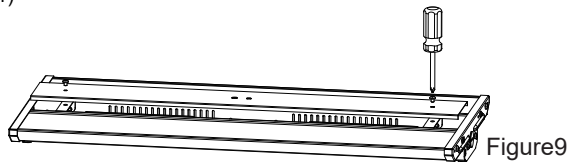
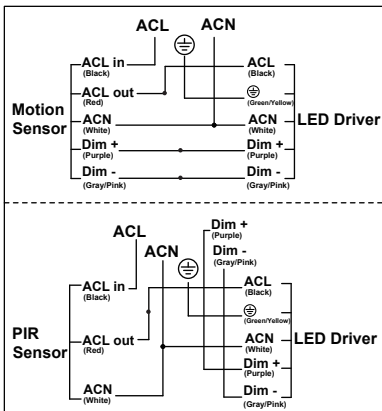

Figure9

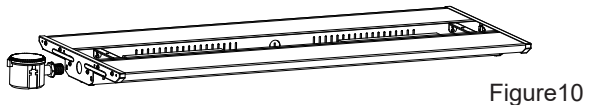

Figure10



Figure11

3.Backup driver:

- Step 1: Knock off the knockout hole on the back of the fixture, take out the wires from the knockout hole (Figure. 12), open the front cover of the fixture, and knock out the two knockout holes on the cover (figure. 13)
- Step 2: Open the cover of the backup driver box, install the backup driver box at the corresponding position on the back of the fixture (figure 14) and connect the wires correspondingly according to the marking instructions on the wire. Mount the buttons and indicators of the backup driver onto the front cover of the fixture (figure 15), then fix the cover to the fixture.
- Step 3: After mounting, choose suitable wiring knockout and carry out the wiring according to local standards and codes.

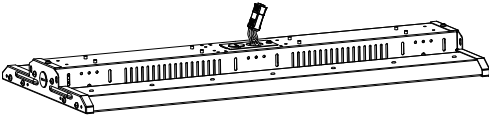

Figure12

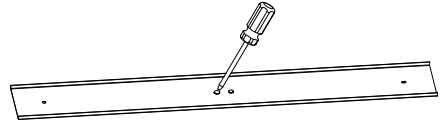

Figure13

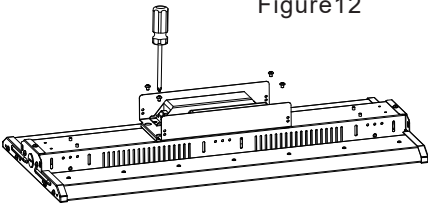

Figure14

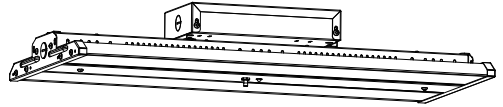

Figure15

Possible maximum product weight (when specific mounts or function is chosen)

Power	Net Weight / Carton	Product Dimension
90W	5.4KG Max	630x300mm
110W	5.4KG Max	630x300mm
135W	5.9KG Max	630x300mm
165W	5.9KG Max	630x300mm
220W	6.5KG Max	630x360mm
220W	8.5KG Max	900x385mm
300W	9.3KG Max	900x385mm
320W	9.3KG Max	900x385mm

Warning / Avertissement

MIN 90°C SUPPLY CONDUCTORS

THIS PRODUCT MUST BE INSTALLED IN ACCORDANCE WITH THE APPLICABLE INSTALLATION CODE BY A PERSON FAMILIAR WITH THE CONSTRUCTION AND OPERATION OF THE PRODUCT AND THE HAZARDS INVOLVED.

The device complies with part 15 of the FCC Rules. Operation is subject to the following two conditions: (1) This device may not cause harmful interference, and (2) this device must accept any interference received, including interference that may cause undesired operation.